







# NEW PRODUCT UPDATE: Front Load Soft Signage Tensioning System

	Part	Part Number	Length	Finish
	Front Load Soft Signage Tension Frame	3092 3092A	20'-0" 20'-0"	Mill Clear Anodized
	Soft Signage 2 Piece Grip Strip	3098	10'-0"	Black
	2 Piece Corner Key	5890		
	Front Load Soft Signage Pull Tab Assembly	5897		
	Soft Signage Tension Frame Z-Clip	3099	12'-0"	Mill

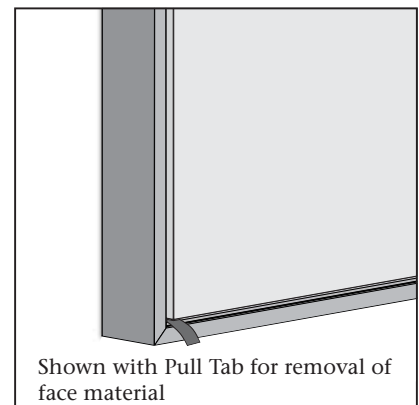
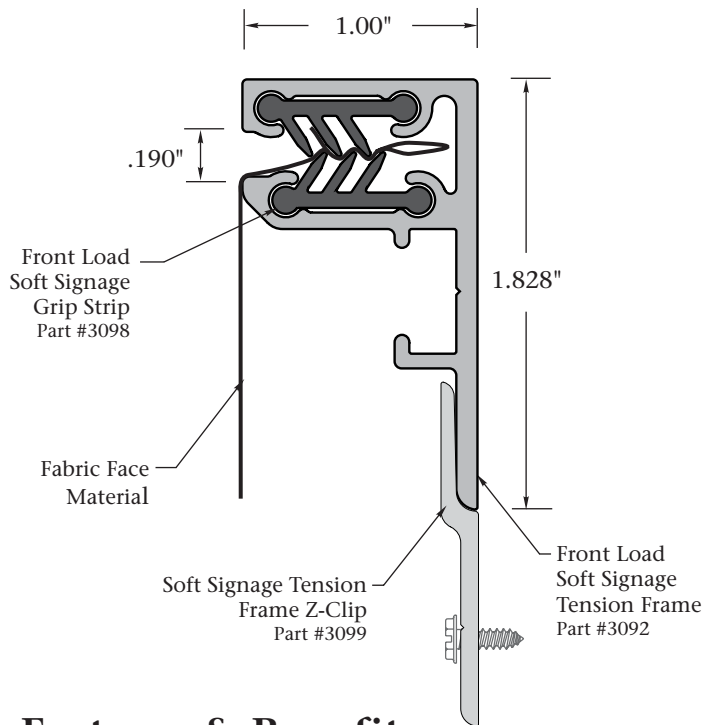

## Features & Benefits

- *No sewing or silicone beads required*
- Fabric does not need to be cut to exact size
- No special tool required for tensioning
- Fast, easy frame assembly
- Designed for narrow non-illuminated applications
- Light weight 1 piece design - No cover needed
- Pull tab remains attached to the frame
- Available in clear anodized or Mill finish
- Mounts directly to the wall or suspended with the Soft Signage Tension Frame Z-Clip, Part # 3099

US Patent Number 8,595,966  
Canadian Patent Number 2,754,507