

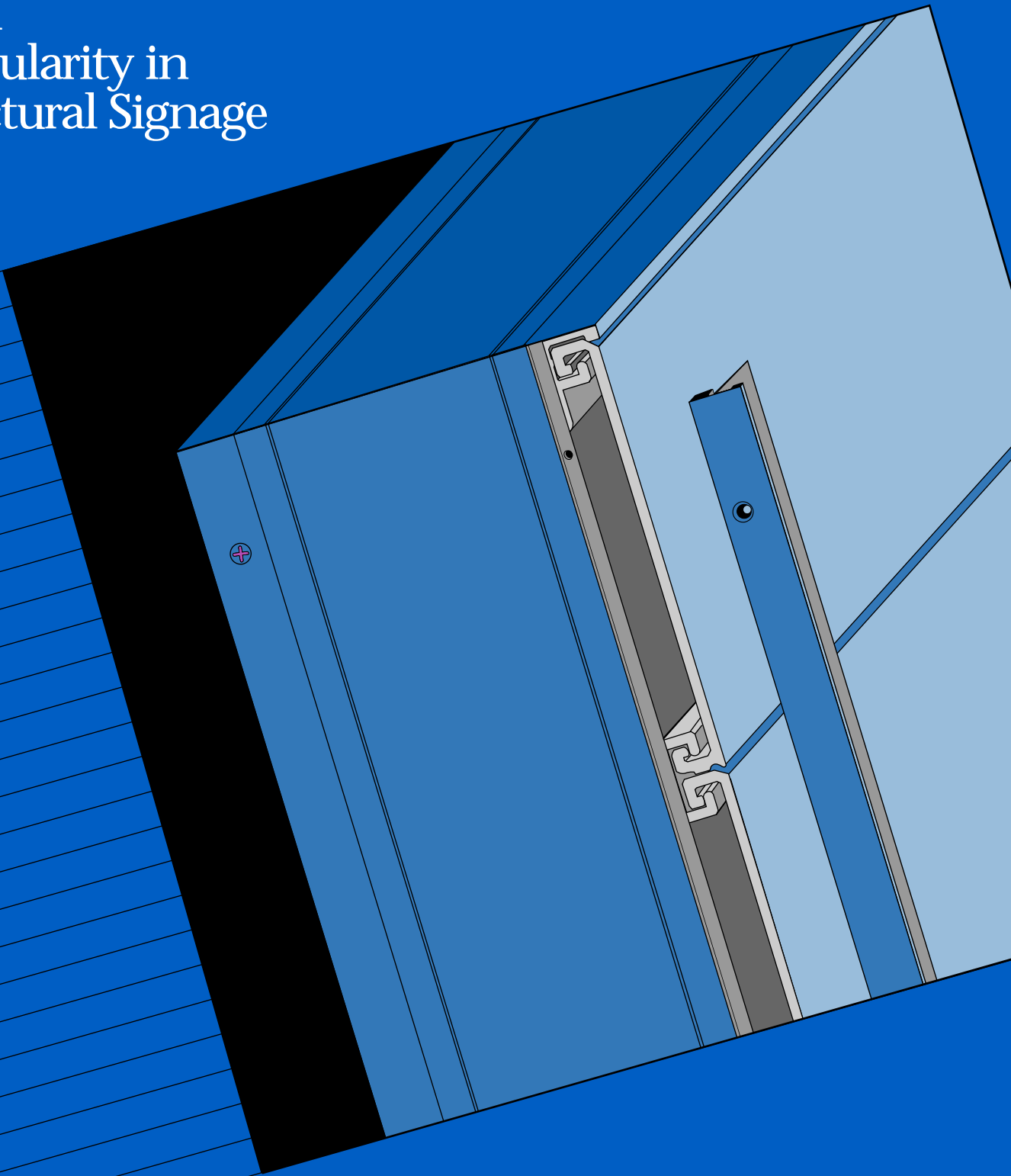

INSERT PANEL
SYSTEM
for Modularity in
Architectural Signage





SignComp products offer mounting options

Internal Mounting System- Inboard Posts

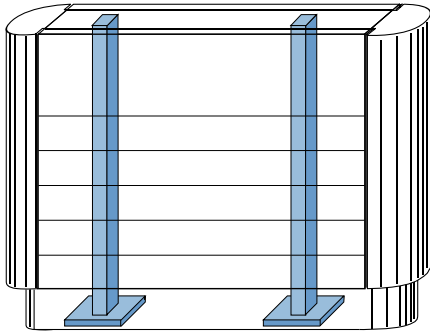

Base Plate Mounting

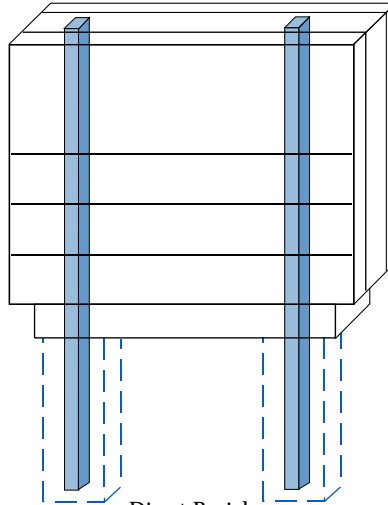

Direct Burial

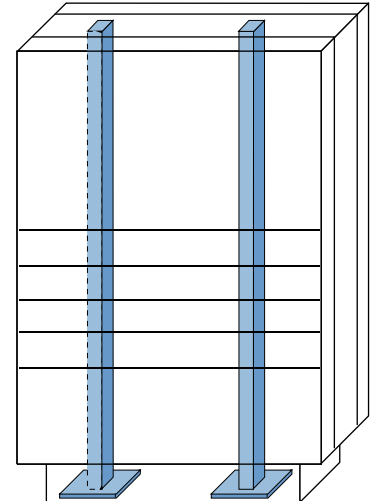

Base Plate Mounting

Fabricated base skirts are easily removed for access to mounting plates

Wall projection, ceiling mount and sleeve mounting applications are available options

External Mounting System- Outboard Posts

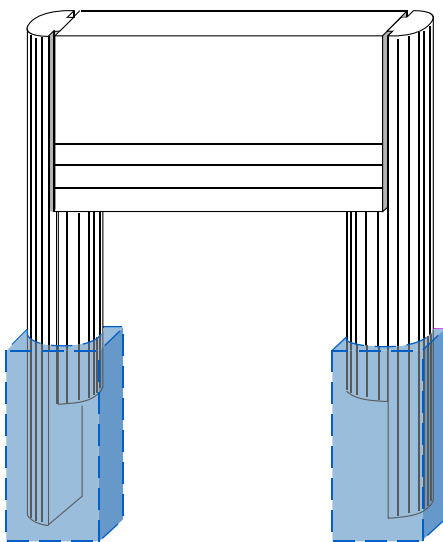

Direct Burial

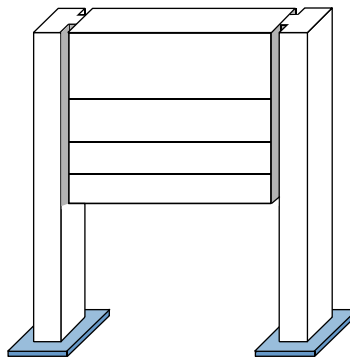

Base Plate Mounting

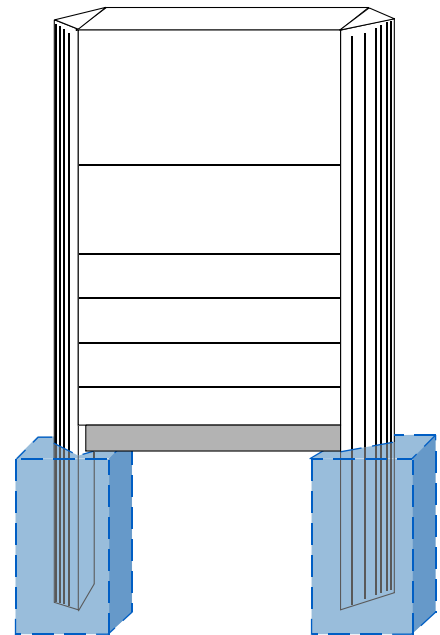

Direct Burial

Wall projection, ceiling mount and sleeve mounting applications are available options



A simple new approach to flush changeable message panels

SignComp's

Insert Panels are:

- Quickly removable
- Completely interchangeable
- Easily replaceable

They simply slide in and out after the Insert Panel End Cover is removed.

- Illuminated applications
- Non-illuminated applications
- Hingeable and Non-hingeable aluminum framework
- Flush frameless appearance
- Concealed structural divider

Choice of custom size panels

Custom height panels may be placed anywhere on the face

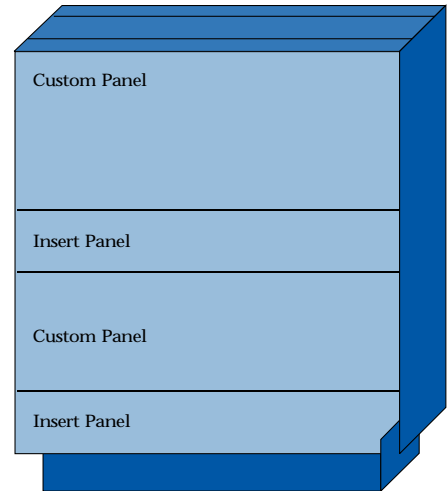

Choice of three Extruded Aluminum Insert Panels 4", 6" and 8" or create custom height Aluminum Insert Panels by fixing Top and Bottom Aluminum Insert Adaptors to .090" aluminum sheet

- Extruded aluminum
- 16'1" extruded lengths
- Clear anodized to facilitate the sliding motion
- For illuminated applications: Routed out graphics backed with plastic
- For non-illuminated applications: Painted or applied vinyl graphics

Create custom height Plastic Insert Panels by fixing Top and Bottom Plastic Insert Adaptors to .125" plastic sheet

- Extruded modified DR white acrylic
- 8'1" extruded lengths
- For illuminated applications: Surface painted opaque background over applied masking films (applied masking films are removed to reveal translucent graphics)
- For non-illuminated applications: Painted or applied vinyl graphics

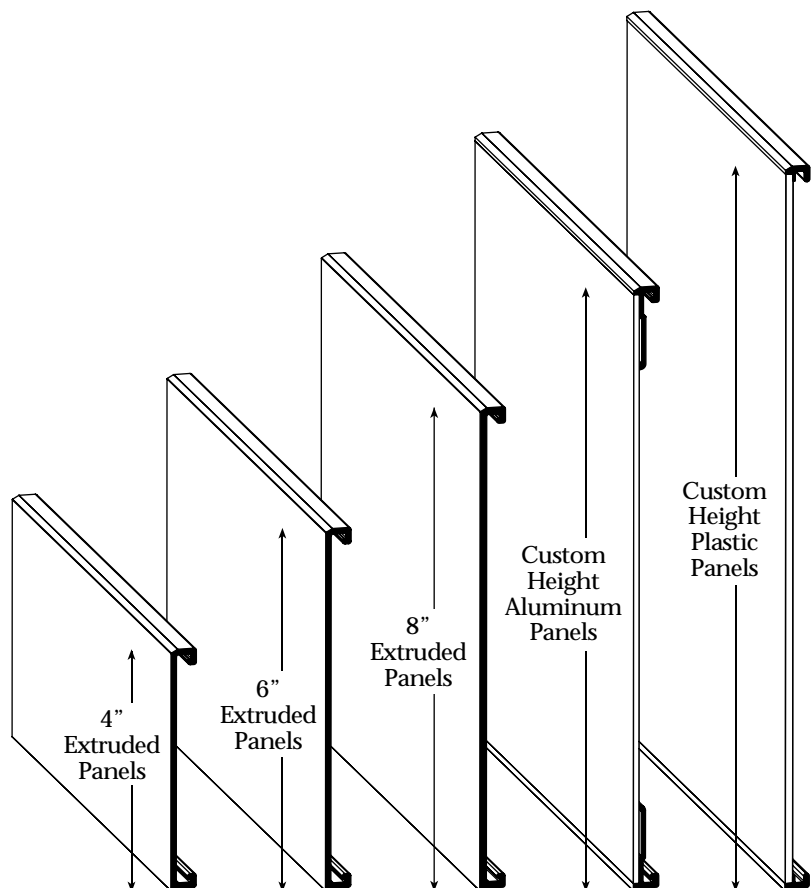



SignComp products offer variety for design applications

Series 12 Hinge Body

Part #1612

For low profile, hingeable applications

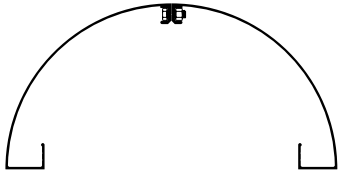

6" Radius
1/4 Round End
Part #1671

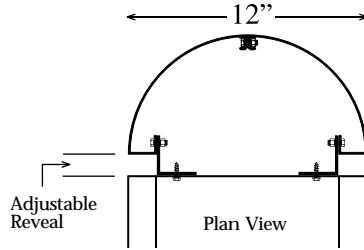

Available with or without 6" Radius Ends

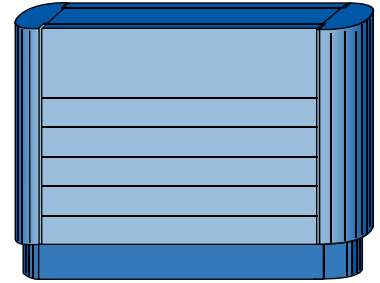

Elevation View

Series 7 Hinge Body

Part #1592

For post & panel, hingeable applications

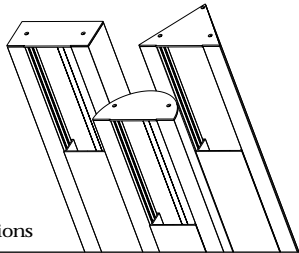

3 Post
Selections

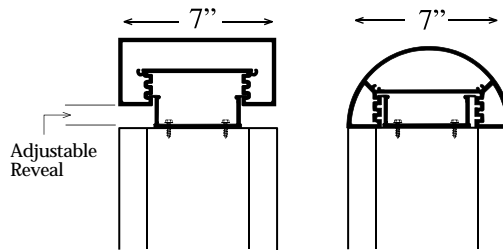

Plan View

Plan View

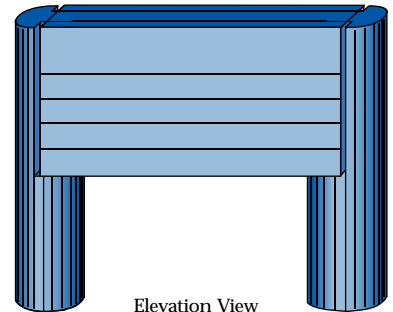

Elevation View

Series 7 Single Face Hinge Body

Part #1602

For wall mounted, hingeable applications

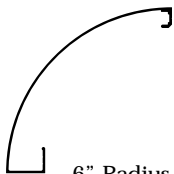

6" Radius
1/4 Round End
Part #1671

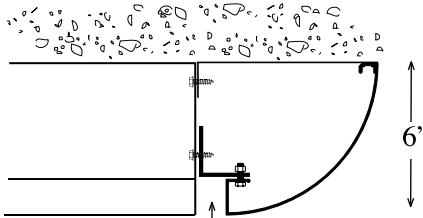

Plan View

Adjustable
Reveal

Available with or without 6" Radius Ends

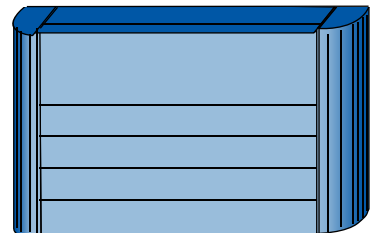

Elevation View

Series 3 Access Body

Part #1290

For non-illuminated, post & panel applications

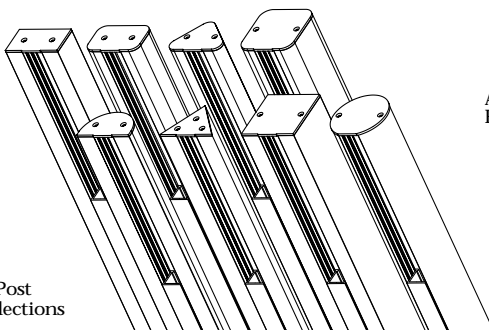

8 Post
Selections

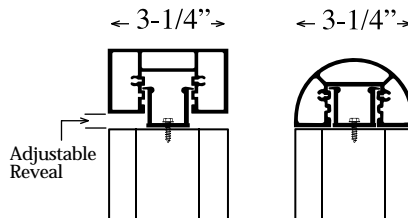

Plan View

Plan View

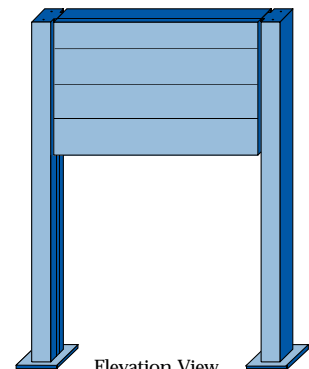

Elevation View

Series 7/12 Retro Body

Part #1600

For retro fit or custom depth applications

Custom depth, hingeable, single or double face applications are achieved by attaching the Series 7/12 Retro Body to fabricated or existing sign cabinet frames.



The simplicity of SignComp's changeable Insert Panels on hingeable aluminum frames

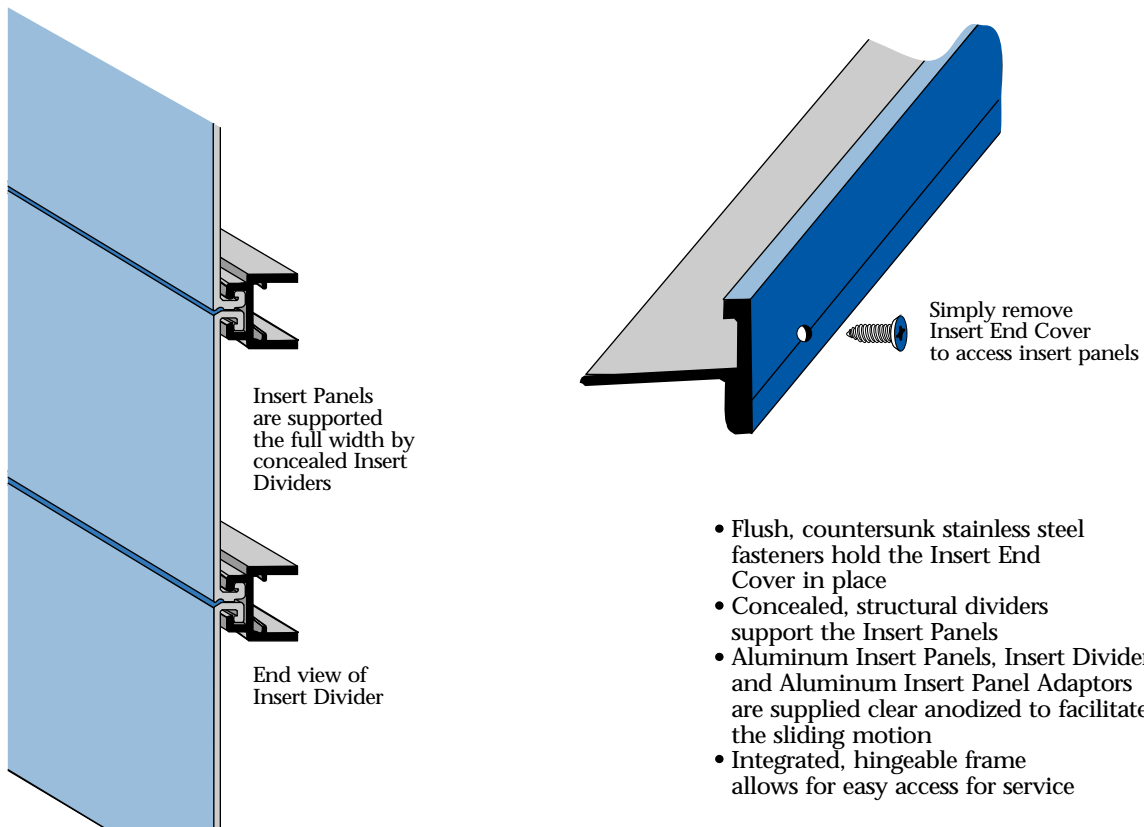
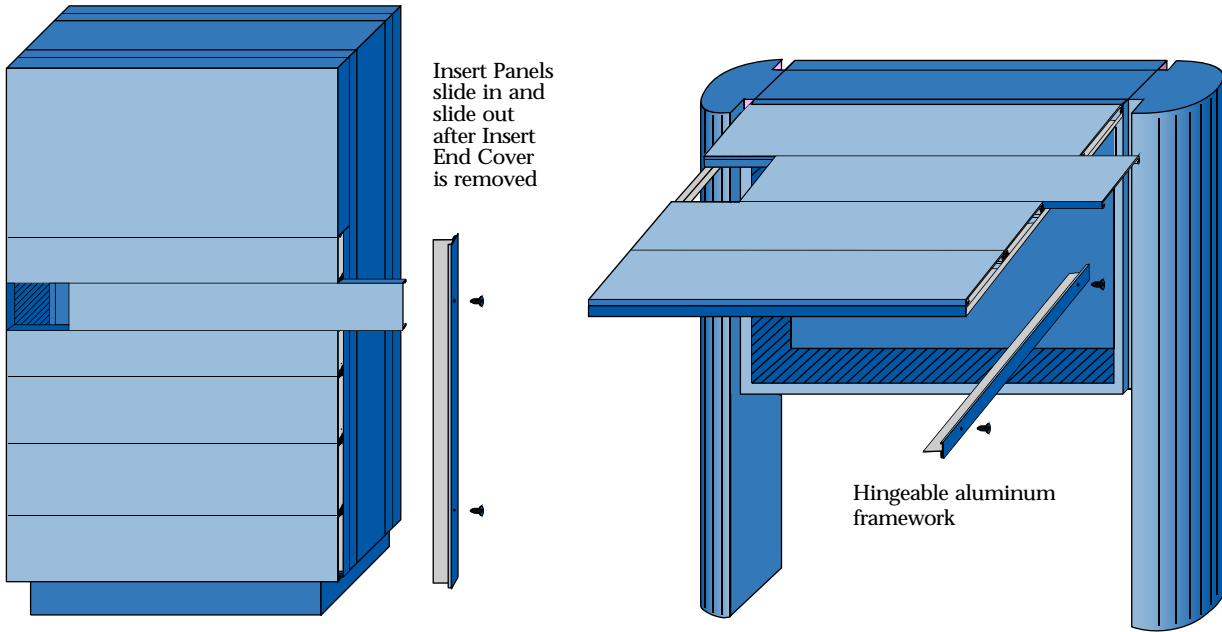

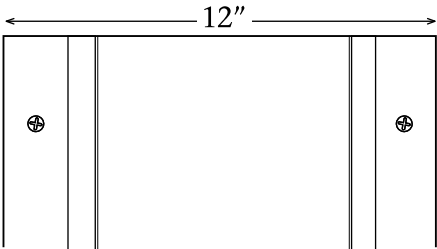
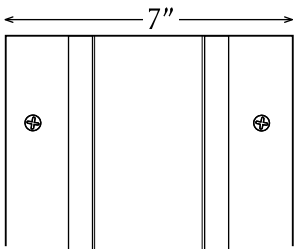
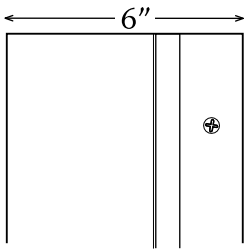
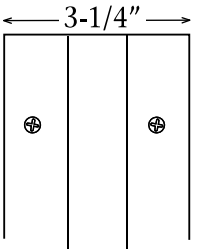
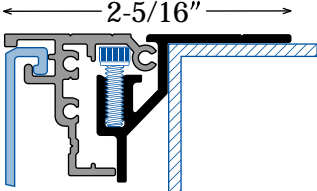

Available in Series 3, 7 and 12

 <p>12"</p>	 <p>7"</p>	 <p>6"</p>	 <p>3-1/4"</p>
<p>Series 12 Hinge Body Part #1612 Double face, ground mounted, hingeable applications</p>	<p>Series 7 Hinge Body Part #1592 Double face, post & panel, hingeable applications</p>	<p>Series 7 Single Face Hinge Body Part #1602 Single face, wall mounted, hingeable applications</p>	<p>Series 3 Access Body Part #1290 Double Face, post & panel, non-hingeable applications</p>
<p>Series 7/12 Retro Body Part #1600 Double face or single face, post & panel or ground mounted, hingeable applications</p>	 <p>2-5/16"</p>	<p>Custom depth, hingeable, single or double face applications are achieved by attaching the Series 7/12 Retro Body to fabricated or existing sign cabinet frames.</p>	

The Insert Panel System easily integrates with:

- Series 12 Hinge Body
- Series 7 Hinge Body
- Series 7 Single Face
- Series 3 Access Body
- Series 7/12 Retro Body

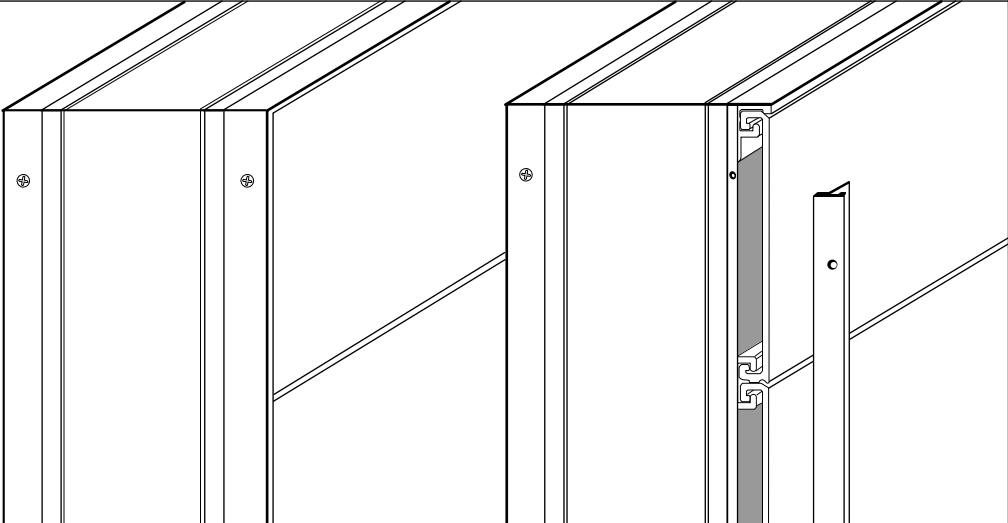

Choice of two End Covers

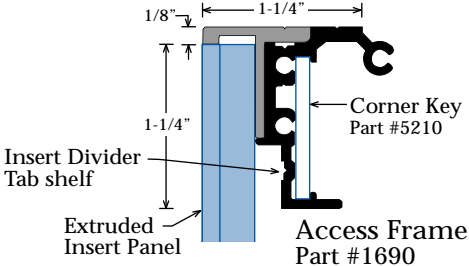
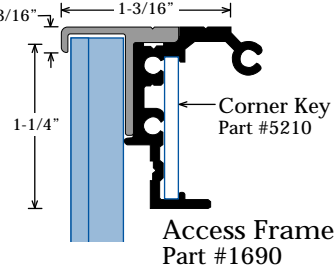
<p>Insert End Cover Part #1696</p>  <p>1/8" 1-1/4" 1-1/4"</p> <p>Insert Divider Tab shelf</p> <p>Extruded Insert Panel</p> <p>Corner Key Part #5210</p> <p>Access Frame Part #1690</p>	<p>Extended Insert End Cover Part #1698</p>  <p>3/16" 1-3/16" 1-1/4"</p> <p>Corner Key Part #5210</p> <p>Access Frame Part #1690</p>
--	---